

SECTION **HRN**
HORN

A
B
C
D
E
F
G
H
I
J
K
M
N
O
P

CONTENTS

DTC/CIRCUIT DIAGNOSIS	2	Precaution for Supplemental Restraint System (SRS) "AIR BAG" and "SEAT BELT PRE-TENSIONER"	5
HORN	2	Precaution for Battery Service	5
Wiring Diagram - HORN -	2	REMOVAL AND INSTALLATION	6
PRECAUTION	5	HORN	6
PRECAUTIONS	5	Exploded View	6
		Removal and Installation	6

HRN

HORN

< DTC/CIRCUIT DIAGNOSIS >

DTC/CIRCUIT DIAGNOSIS

HORN

Wiring Diagram - HORN -

INFOID:000000004249148

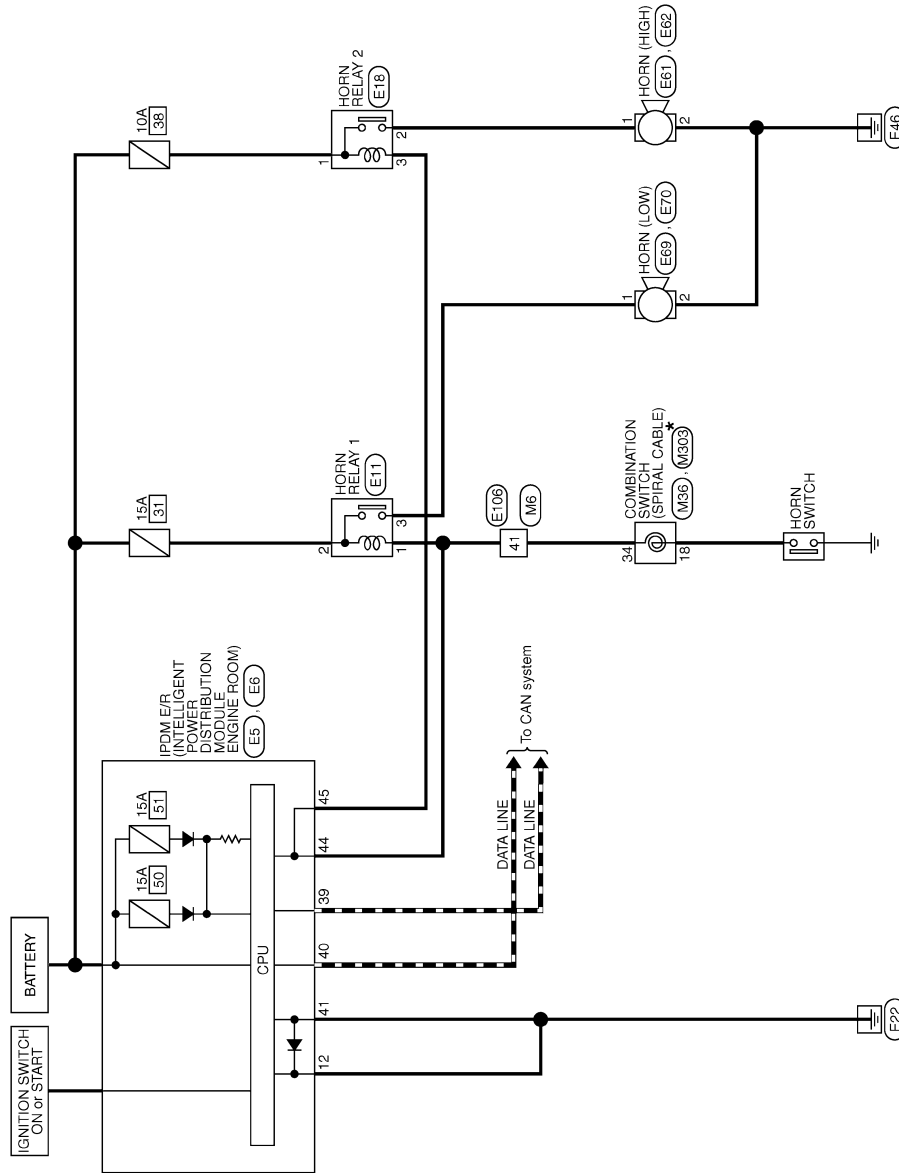

*: This connector is not shown in "Harness Layout".

HORN

2008/08/22

JCLWM2731GE

HORN

< DTC/CIRCUIT DIAGNOSIS >

HORN

Connector No.	E5
Connector Name	IPDM E/R (INTELLIGENT POWER DISTRIBUTION MODULE ENGINE ROOM)
Connector Type	TH20FW-CS12-M4-TV

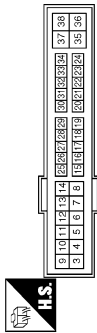

Terminal No.	Color of Wire	Signal Name [Specification]
12	B/W	-

Connector No.	E6
Connector Name	IPDM E/R (INTELLIGENT POWER DISTRIBUTION MODULE ENGINE ROOM)
Connector Type	TR03FW-HH

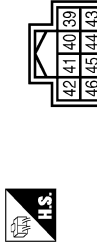

Terminal No.	Color of Wire	Signal Name [Specification]
39	P	-
40	L	-
41	B/W	-
44	W	-
45	G	-

Connector No.	E11
Connector Name	HORN RELAY 1
Connector Type	243817300A



Terminal No.	Color of Wire	Signal Name [Specification]
1	LG	-
2	SB	-
3	Y	-

Connector No.	E18
Connector Name	HORN RELAY 2
Connector Type	IM03FW-R-LC



Terminal No.	Color of Wire	Signal Name [Specification]
1	P	-
2	Y	-
3	G	-

Connector No.	E81
Connector Name	HORN (HIGH)
Connector Type	P01FE-A

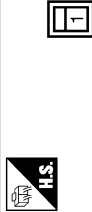

Terminal No.	Color of Wire	Signal Name [Specification]
1	Y	-

Connector No.	E62
Connector Name	HORN (HIGH)
Connector Type	P01FB-A



Terminal No.	Color of Wire	Signal Name [Specification]
2	B	-

Connector No.	E69
Connector Name	HORN (LOW)
Connector Type	P01FB-A

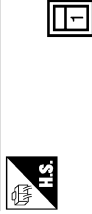

Terminal No.	Color of Wire	Signal Name [Specification]
1	Y	-

Connector No.	E70
Connector Name	HORN (LOW)
Connector Type	P01FB-A

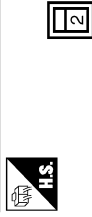



Terminal No.	Color of Wire	Signal Name [Specification]
2	B	-

JCLWM2732GE

A
B
C
D
E
F
G
H
I
J
K
HRN
M
N
O
P

HORN

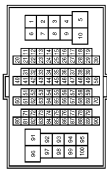
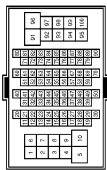
< DTC/CIRCUIT DIAGNOSIS >

HORN		
Connector No.	E106	
Connector Name	WIRE TO WIRE	
Connector Type	TH807V-CS16-TM4	
Terminal No.	41	LG
Color of Wire	LG	
Signal Name [Specification]		
Terminal No.	41	LG
Color of Wire	LG	
Signal Name [Specification]		
Connector No.	M6	
Connector Name	WIRE TO WIRE	
Connector Type	TH808V-CS16-TM4	
Terminal No.	41	LG
Color of Wire	LG	
Signal Name [Specification]		
Terminal No.	34	LG
Color of Wire	LG	
Signal Name [Specification]		
Connector No.	M36	
Connector Name	COMBINATION SWITCH (SPIRAL CABLE)	
Connector Type	TK08FGY-IV	
Terminal No.	34	LG
Color of Wire	LG	
Signal Name [Specification]		
Terminal No.	18	G
Color of Wire	G	
Signal Name [Specification]		
Connector No.	M303	
Connector Name	COMBINATION SWITCH (SPIRAL CABLE)	
Connector Type	TK08FGY	
Terminal No.	18	G
Color of Wire	G	
Signal Name [Specification]		

JCLWM2733GE

PRECAUTIONS

< PRECAUTION >

PRECAUTION

PRECAUTIONS

Precaution for Supplemental Restraint System (SRS) "AIR BAG" and "SEAT BELT PRE-TENSIONER"

INFOID:000000004249149

The Supplemental Restraint System such as "AIR BAG" and "SEAT BELT PRE-TENSIONER", used along with a front seat belt, helps to reduce the risk or severity of injury to the driver and front passenger for certain types of collision. This system includes seat belt switch inputs and dual stage front air bag modules. The SRS system uses the seat belt switches to determine the front air bag deployment, and may only deploy one front air bag, depending on the severity of a collision and whether the front occupants are belted or unbelted. Information necessary to service the system safely is included in the "SRS AIR BAG" and "SEAT BELT" of this Service Manual.

WARNING:

- To avoid rendering the SRS inoperative, which could increase the risk of personal injury or death in the event of a collision which would result in air bag inflation, all maintenance must be performed by an authorized NISSAN/INFINITI dealer.
- Improper maintenance, including incorrect removal and installation of the SRS, can lead to personal injury caused by unintentional activation of the system. For removal of Spiral Cable and Air Bag Module, see the "SRS AIR BAG".
- Do not use electrical test equipment on any circuit related to the SRS unless instructed to in this Service Manual. SRS wiring harnesses can be identified by yellow and/or orange harnesses or harness connectors.

PRECAUTIONS WHEN USING POWER TOOLS (AIR OR ELECTRIC) AND HAMMERS

WARNING:

- When working near the Air Bag Diagnosis Sensor Unit or other Air Bag System sensors with the ignition ON or engine running, DO NOT use air or electric power tools or strike near the sensor(s) with a hammer. Heavy vibration could activate the sensor(s) and deploy the air bag(s), possibly causing serious injury.
- When using air or electric power tools or hammers, always switch the ignition OFF, disconnect the battery, and wait at least 3 minutes before performing any service.

Precaution for Battery Service

INFOID:000000004249150

Before disconnecting the battery, lower both the driver and passenger windows. This will prevent any interference between the window edge and the vehicle when the door is opened/closed. During normal operation, the window slightly raises and lowers automatically to prevent any window to vehicle interference. The automatic window function will not work with the battery disconnected.

A

B

C

D

E

F

G

H

I

J

K

HRN

M

N

O

P

HORN

< REMOVAL AND INSTALLATION >

REMOVAL AND INSTALLATION

HORN

Exploded View

INFOID:000000004249151

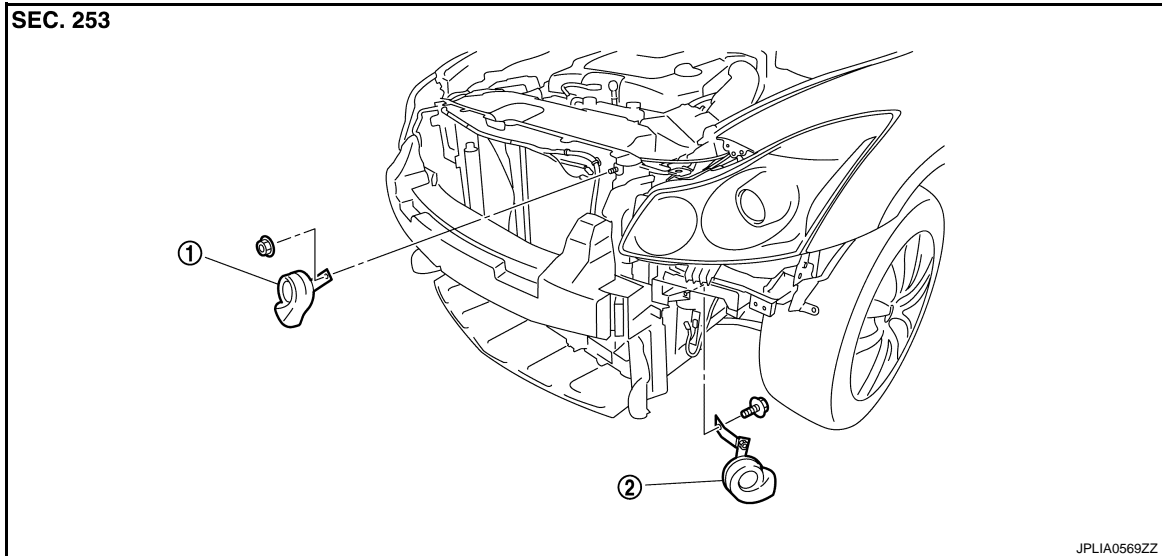

1. Horn (LOW)

2. Horn (HIGH)

Removal and Installation

INFOID:000000004249152

REMOVAL

Horn (LOW)

1. Remove radiator core support ornament. Refer to [DLK-212. "Exploded View"](#).
2. Disconnect the horn (LOW) connector.
3. Remove the horn mounting nut, and remove the horn (LOW) from the vehicle.

Horn (HIGH)

1. Remove fender protector (LH). Refer to [EXT-24. "FENDER PROTECTOR : Exploded View"](#).
2. Disconnect the horn (HIGH) connector.
3. Remove the horn mounting bolt, and remove the horn (HIGH) from the vehicle.

INSTALLATION

Install in the reverse order of removal.